



*Les yeux au
bout des doigts*



Collège le Chapitre



Qui sommes nous ?





Notre problématique ?

Comment faciliter la vie des personnes
ayant une déficience visuelle ?



Notre projet

A qui rend-il service ?



Sur quoi agit-il ?

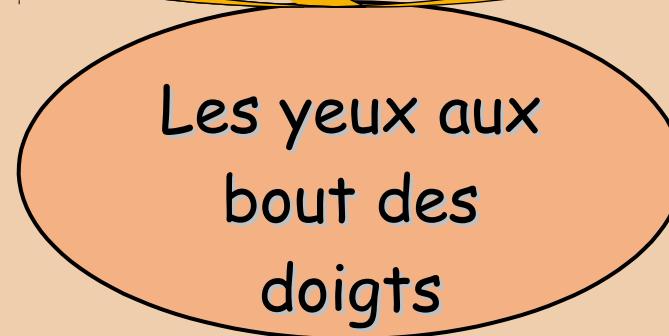

Dans quel but ?

Détecter les obstacles tout en facilitant la vie des personnes ayant une déficience visuelle.

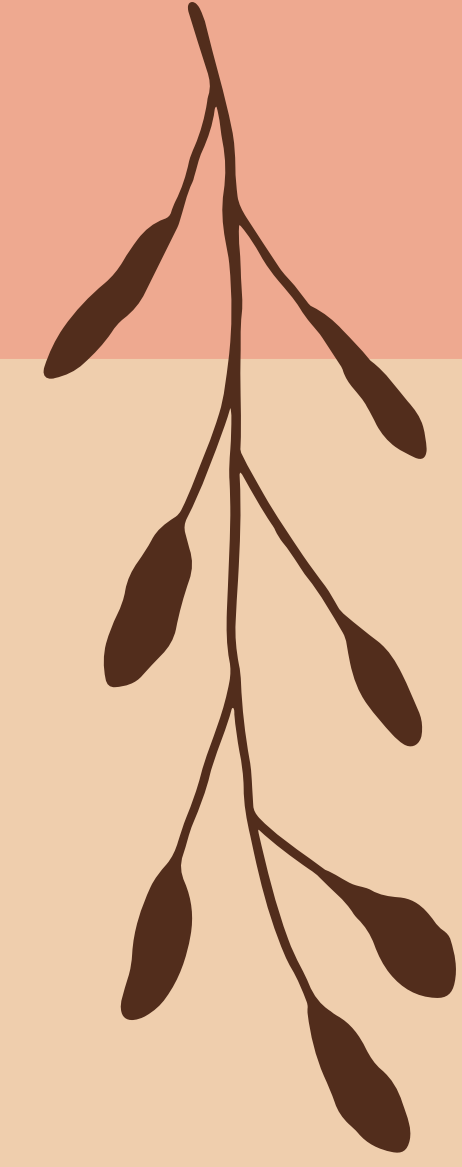

Les composants

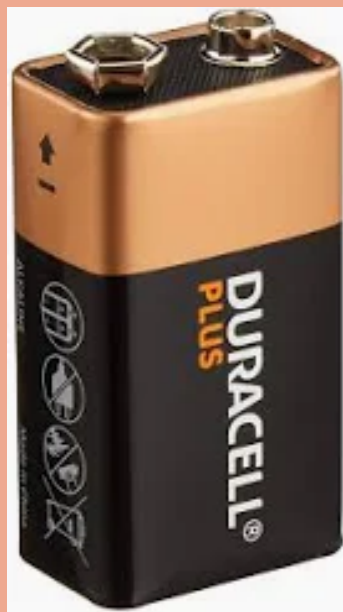

Pile 9V

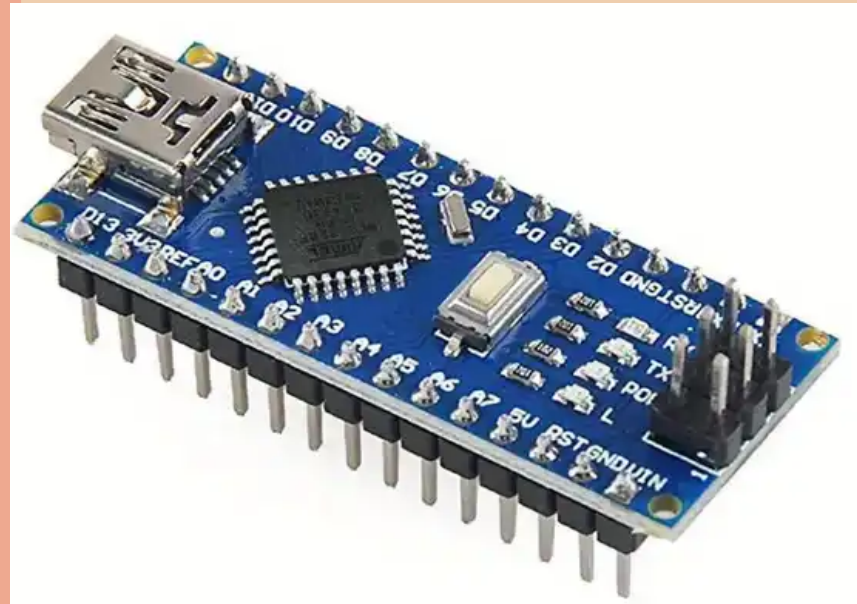

Arduino Nano



Bouton

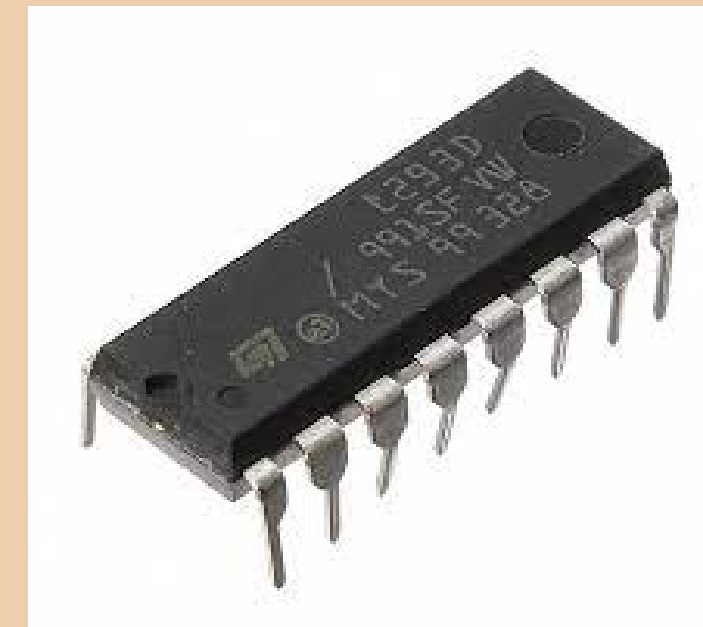

Puce électronique



Moteur vibreur



Condensateur



Résistance



Potentiomètre



Plaque



Capteur ultrason



Capteur à ultrasons



Schéma de câblage



Modélisation 3d

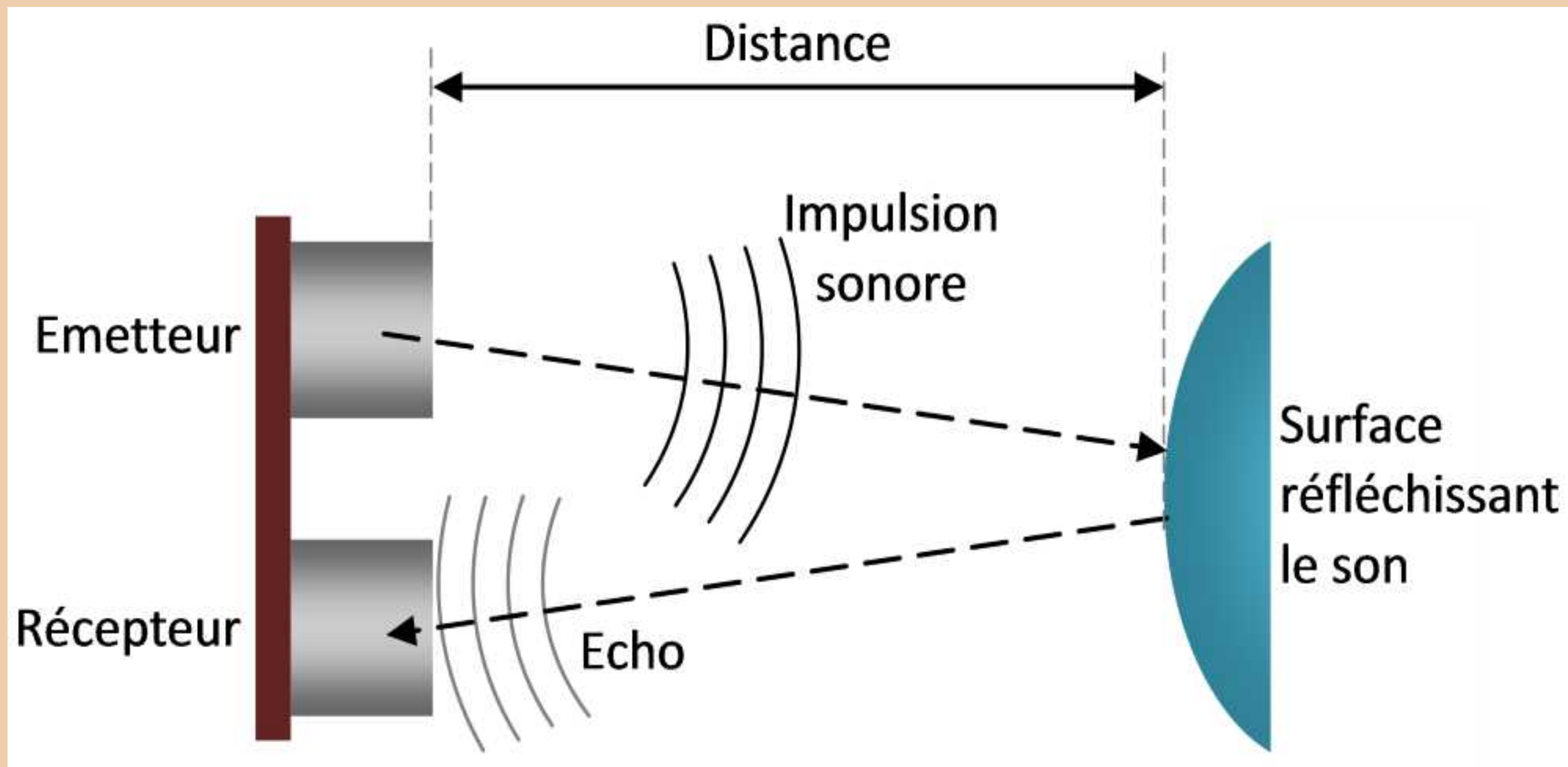
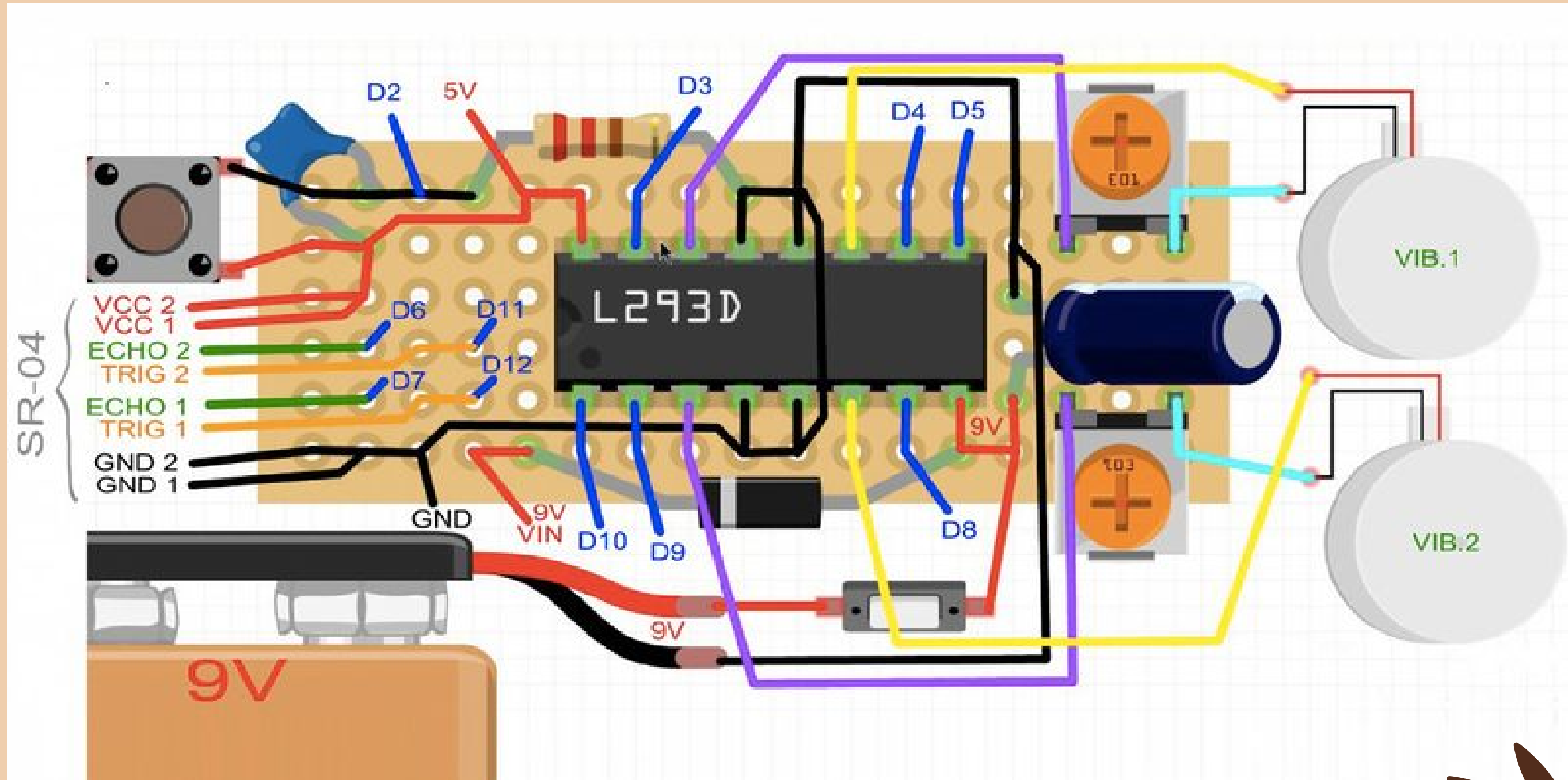
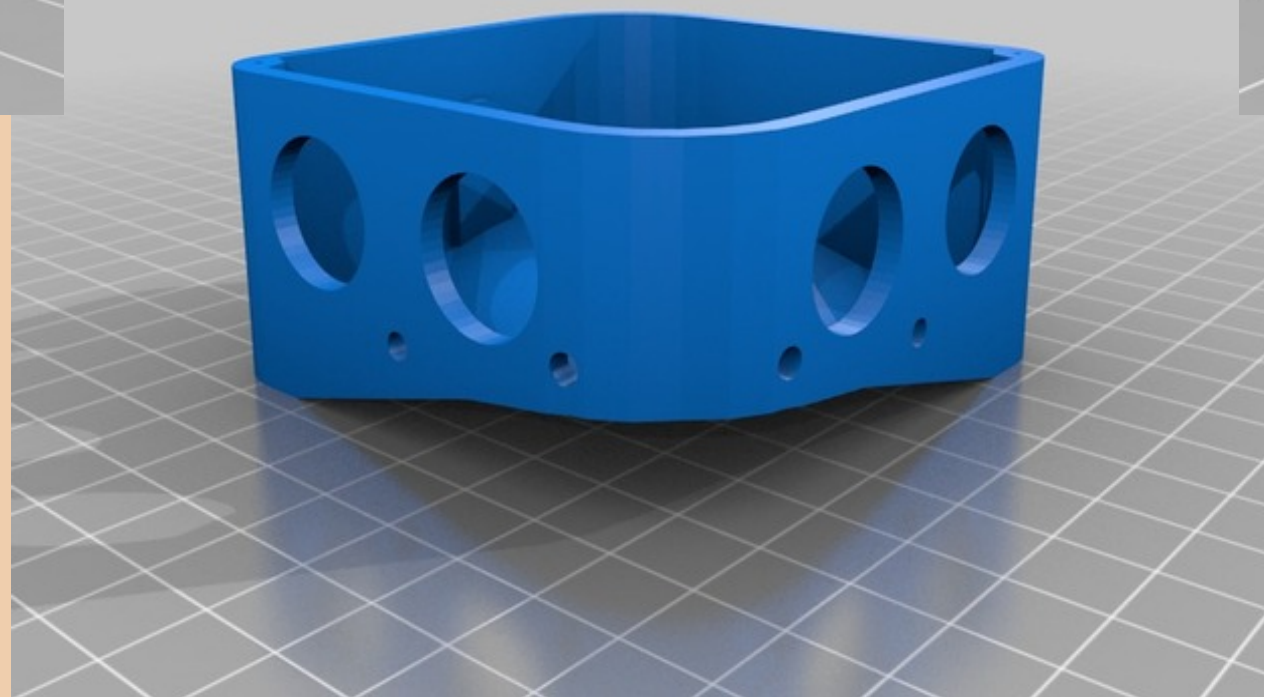
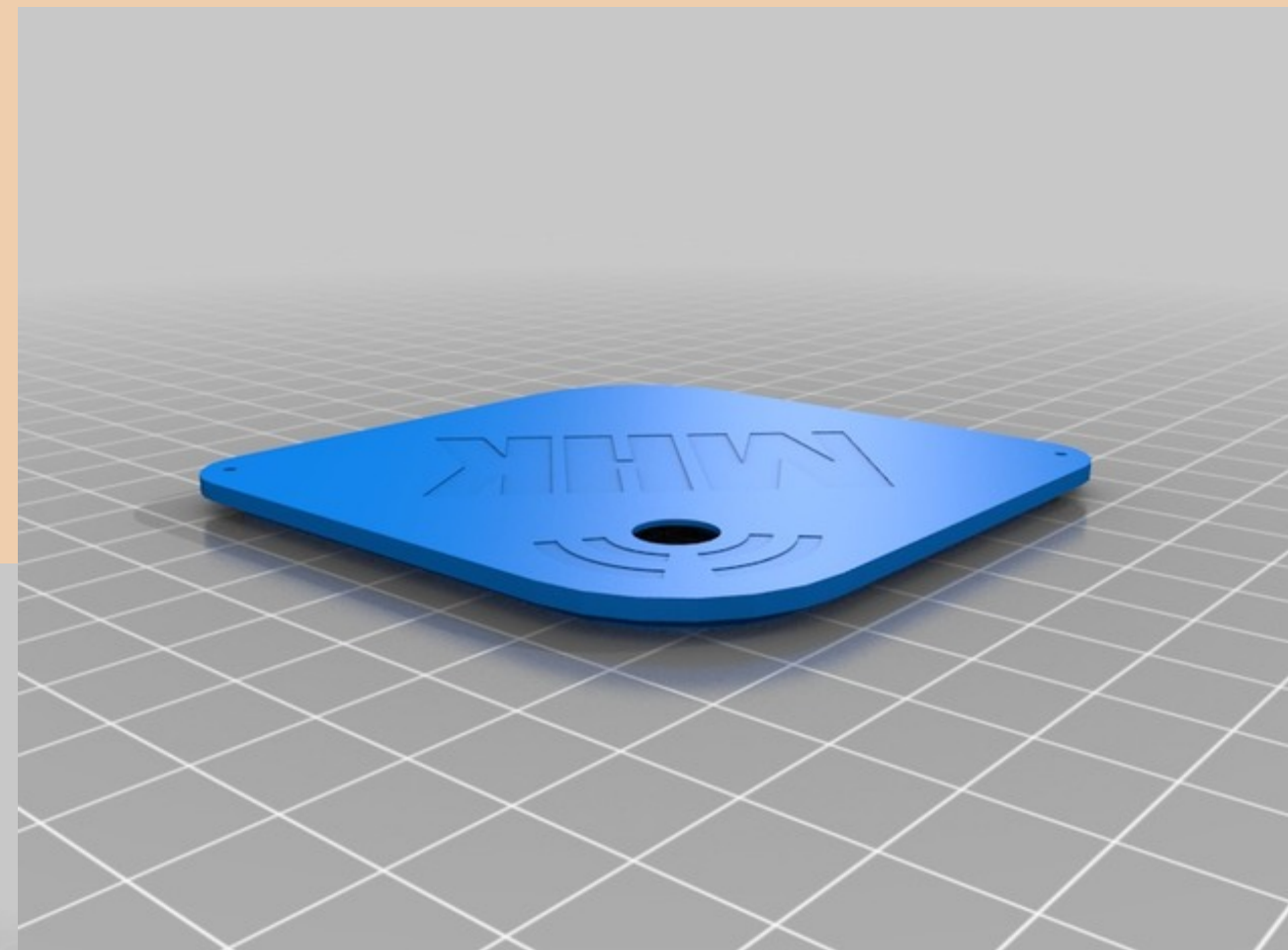
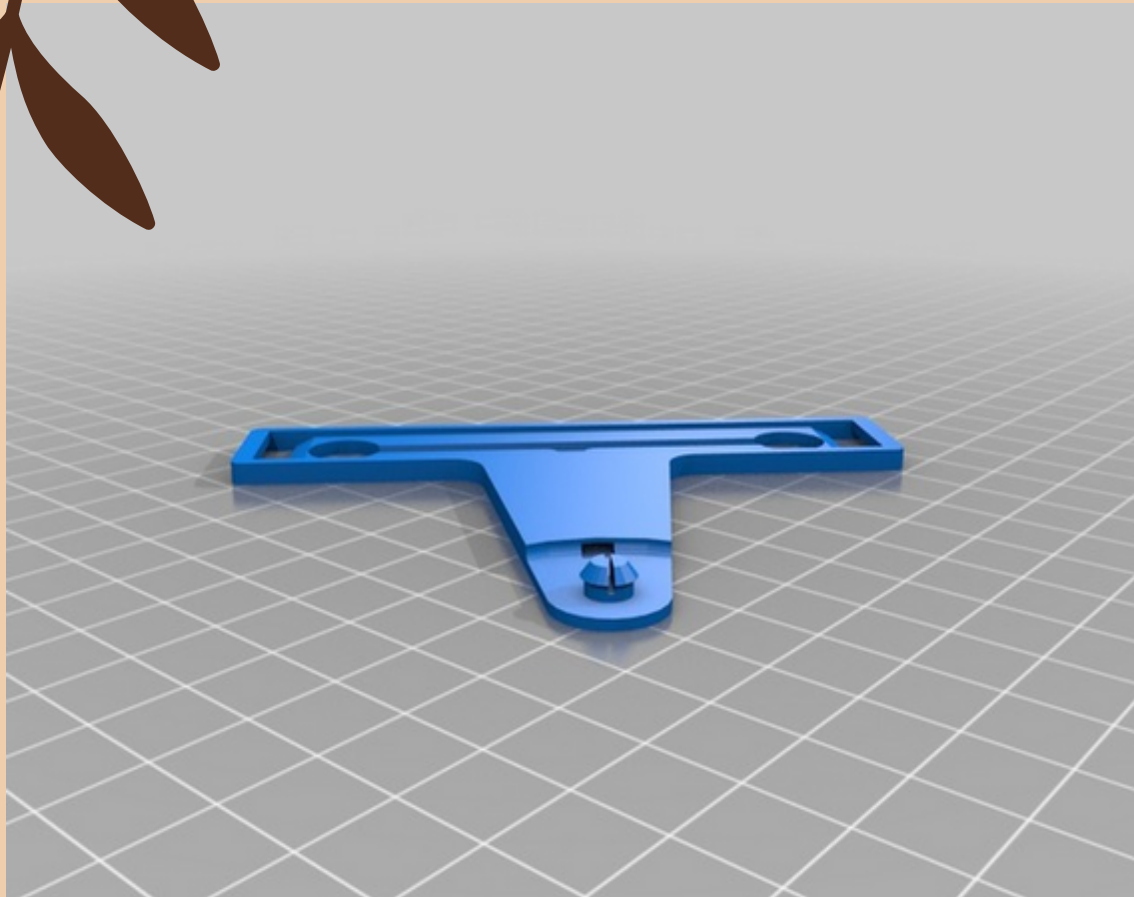

Montage

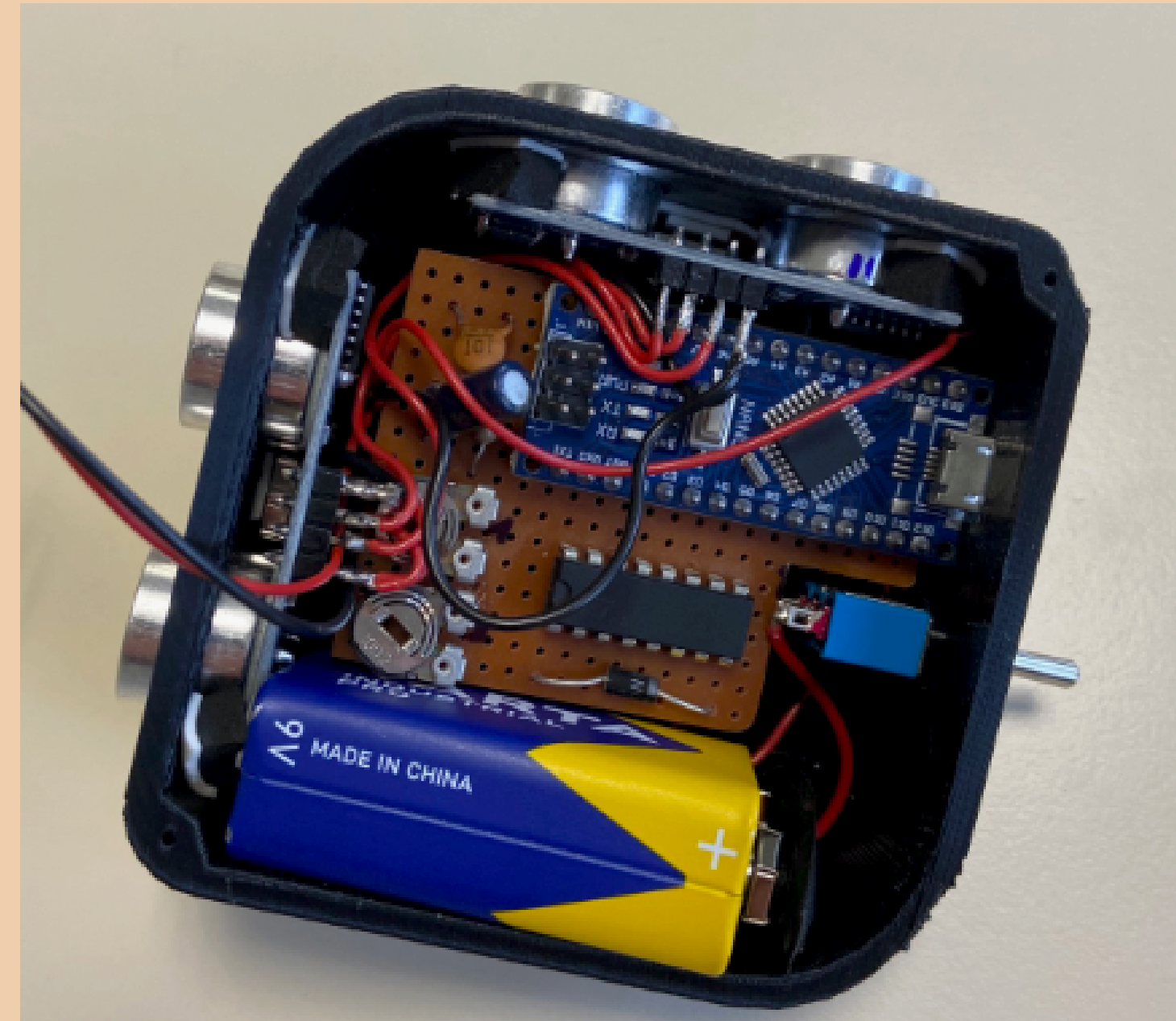
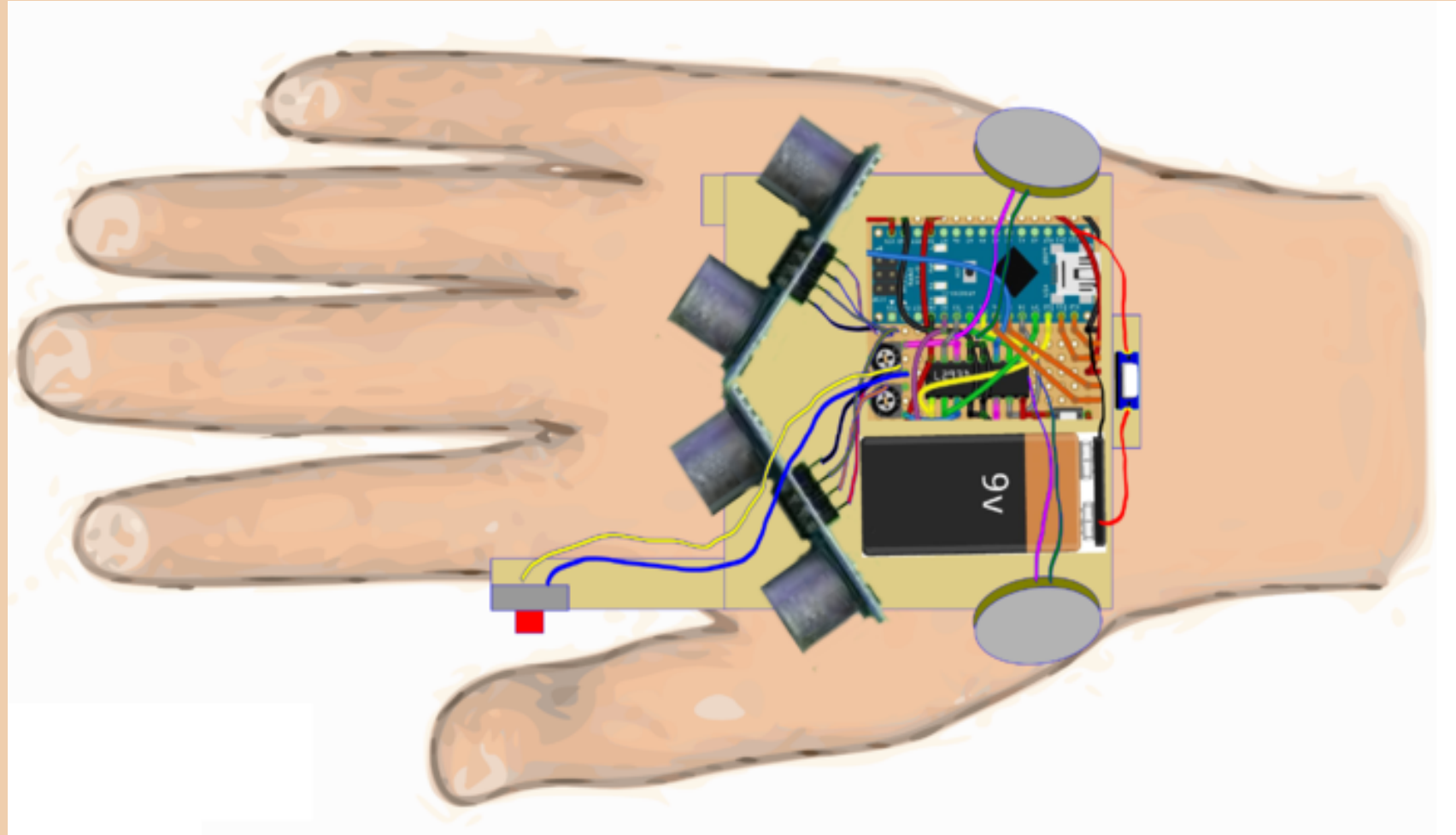



Fonctionnement



Partenariats

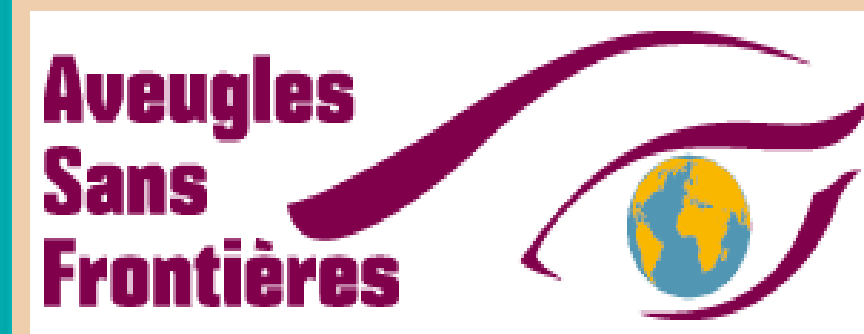



Les yeux au bout des doigts c'est :

Innovant : Facilite la vie des personnes tout en s'intégrant au mieux dans la société.

Intelligent : Sonde en permanence l'environnement et le traduit par des vibrations.

Économique : Accessible à tous (environ 50€)

Durable : Respect de l'environnement



Sciences à l'École

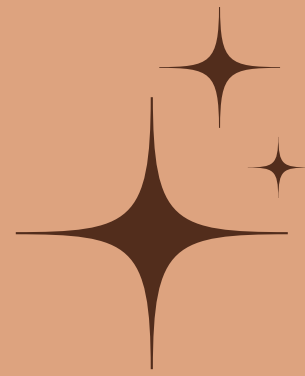

Merci !

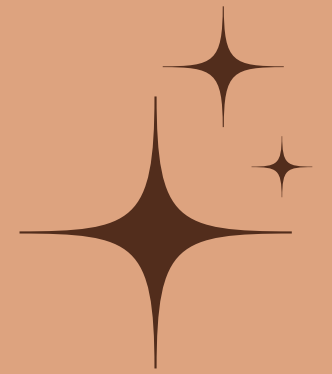

CONCOURS
Collège
Lycée **CGÉNIAL**

FONDATION
CGENIAL